

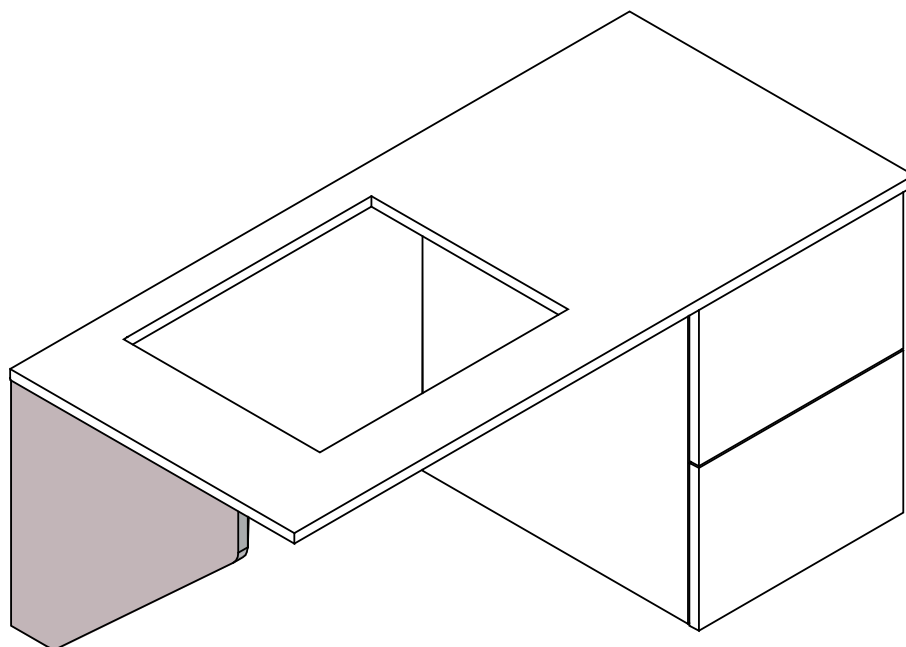





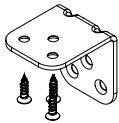

Ensemble PMR

PMR ensemble

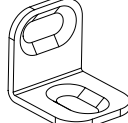
Instructions de montage

Mounting instructions



Quincaillerie / Hardware				Nécessaire (non fourni) / Necessary (not supplied)					
CAC_0001920	CAC_0000697	CAC_0000386							
									
A	B	C					15 mn	X1	

1

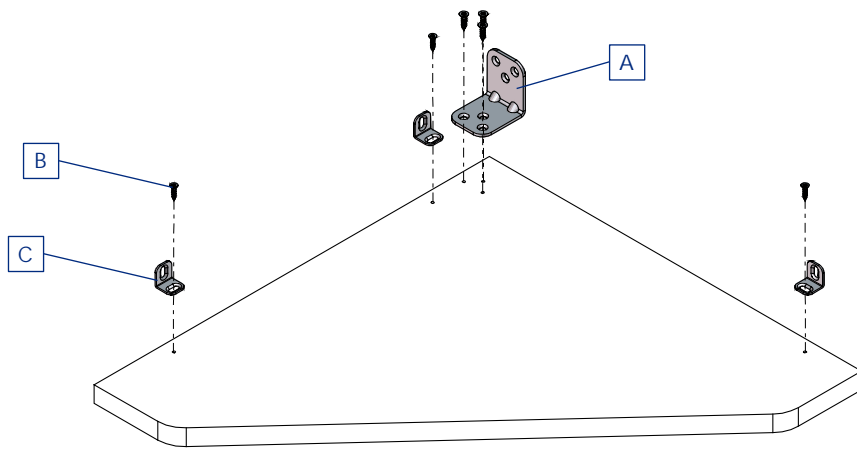

2

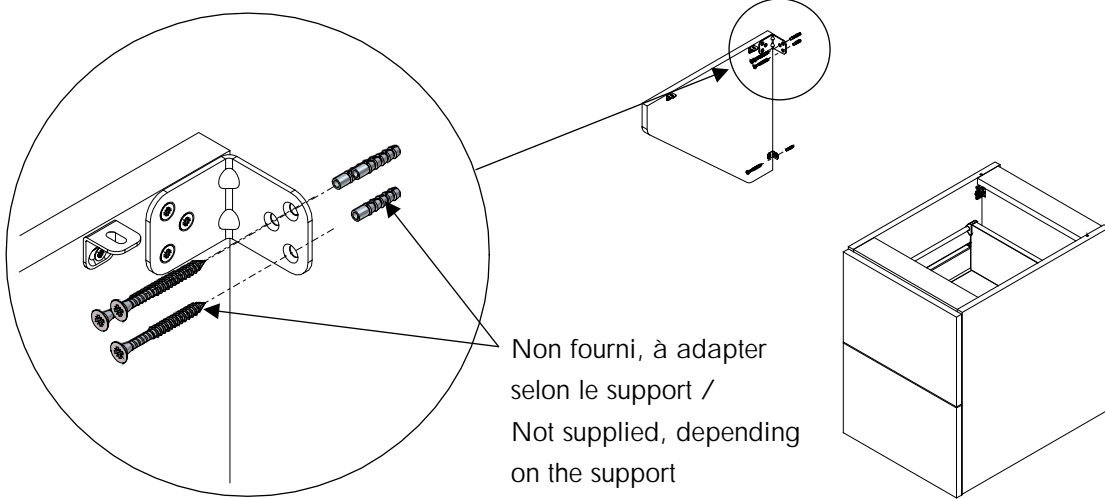

3

